

THE PROPERTY OF THE DRAWING IS ESTABLISHED BY LAW. IT IS FORBIDDEN TO PRODUCE OR SHOW IT TO THIRD PART, WITHOUT A WRITTEN AGREEMENT.

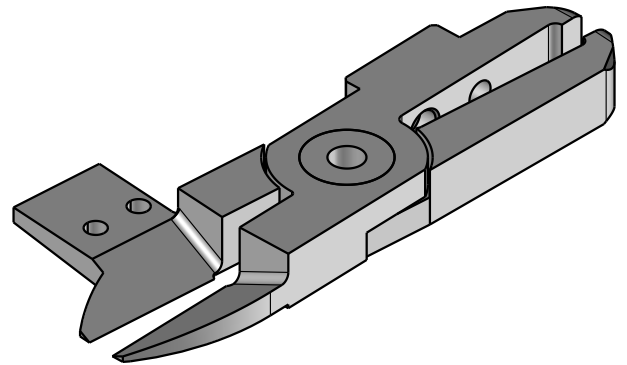
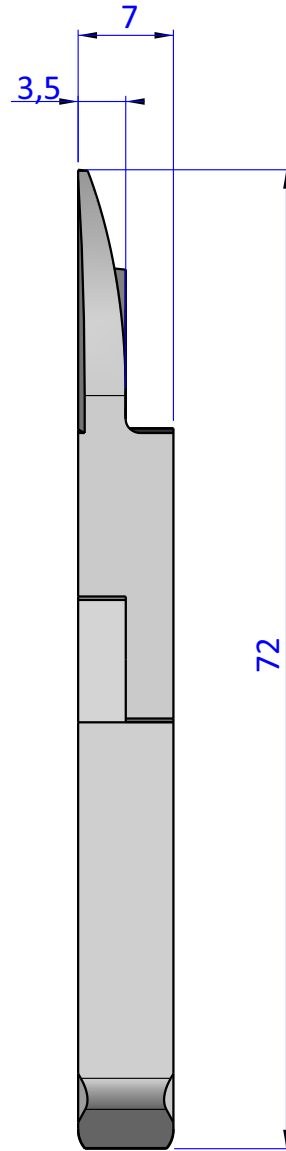
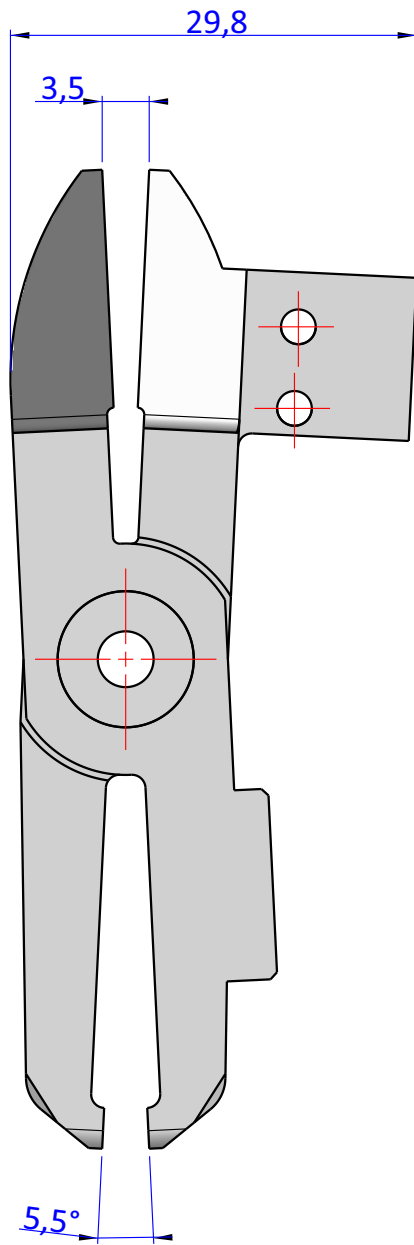

DESIGNED FROM

FPS Automation

REVIEW

A

DATE

27/10/2020

WEIGHT

0,040kg

CODE

VES.NTH05AJ

Format A4

UNI 936-76

GENERAL TOLERANCE

UNI - ISO 2768

CLASSE f

DESCRIPTION

VES.NTH05AJ